

NSF/CTF FEATURES

FRP SIROCCO FAN

MODEL NSF



Model NSF Sirocco Fan is made of the thick FRP sheets offering great safe and mechanical strength. The indented round shape of the suction and discharge opening facilitates connection of the fan to a duct.

• Round suction and discharge flange of identical size

The adoption of round flanges of identical dimension on both the suction and discharge openings has greatly enhanced piping in comparison with the conventional square flanges. Moreover, easy sleeve piping is now possible due to the fact that a duct flange can be employed as a companion flange on fans with a flange size of 500A or less.

• Excellent corrosion resistance

•Casing
FRP material having outstanding chemical resistance has been employed. Besides being rigid against external impact, it has a higher working temperature range than PVC, and has the added advantage of being lighter than metal casing.

•Impeller

While, integral models have been employed in the fabrication of the impellers of NSF-302~402 models which have superb chemical resistance and enhanced mechanical strength.

• Wider capacity range

In comparison with our conventional models, higher static pressure and extended gas volume range achieved with the new model NSF make them more economical.

MEDIUM-PRESSURE FRPP CENTRAL DISCHARGE TURBOFAN

MODEL CTF



Model CTF has an excellent reputation for outstanding value and energy efficiency in medium-pressure-range (1.0–2.0 kPa) applications. This new model features an FRPP central discharge casing offering corrosion resistance and high mechanical strength. As a result, it is easier to operate and maintain.

• Turbofan with standardized central discharge

The use of clockwise rotation alone for central discharge reduces the number of rotating discharge directions to three compared with the six directions available with conventional models. This eliminates troublesome selection of the discharge direction. What's more, both the suction and discharge flanges are round and of the same size, simplifying duct alignment. The layout of the fan is similar to that of elbow piping.

• Ease of maintenance

An easily removable suction cone is provided that allows for simple removal of the impeller through effortless disconnection of the duct on the suction side. Both checking and cleaning of the inside of the casing and replacement of the impeller can be performed with ease.

• Excellent corrosion resistance

FRP impellers made with special resin under our proprietary new manufacturing technology ensures that the turbofan can be used for almost all chemical and gas applications except for those involving solvents and organic compounds.

Typical applications:

- As a corrosive gas fan/blower in a chemical or pharmaceutical plant
- As a draft chamber fan/blower in a chemical laboratory treating various gases
- As a fan/blower in a biotechnology research laboratory or experimental semiconductor laboratory
- As fan/blower in kitchen facilities
- As an odorous gas fan/blower in a sewage treatment facility
- As a fan /blower to eliminate coastal salt pollution

NSF CAPACITY RANGE CHART

NSF302

CAPACITY RANGE CHART

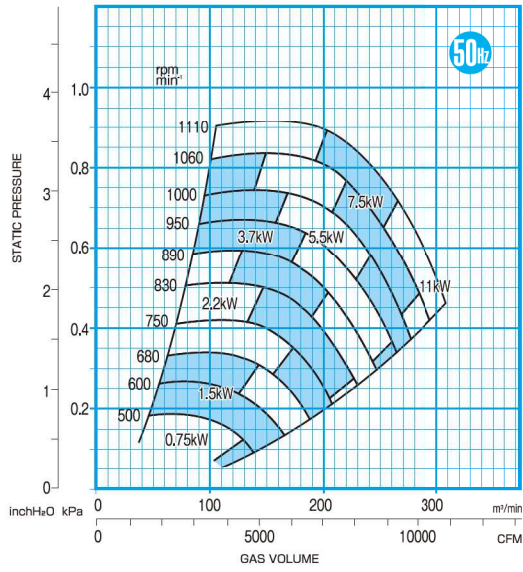

SOUND LEVEL

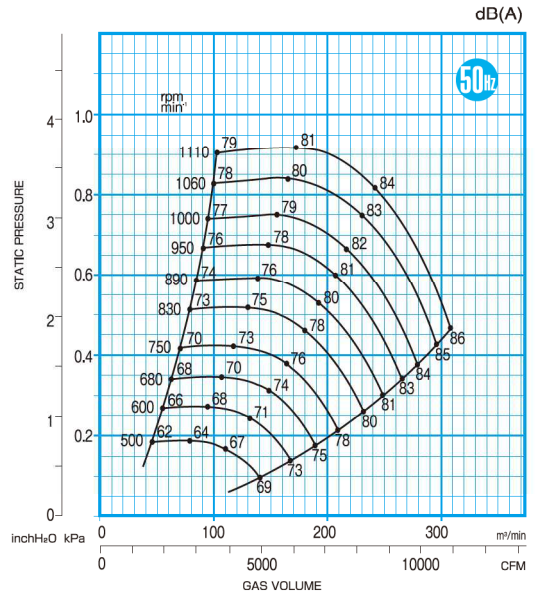

NSF402

CAPACITY RANGE CHART

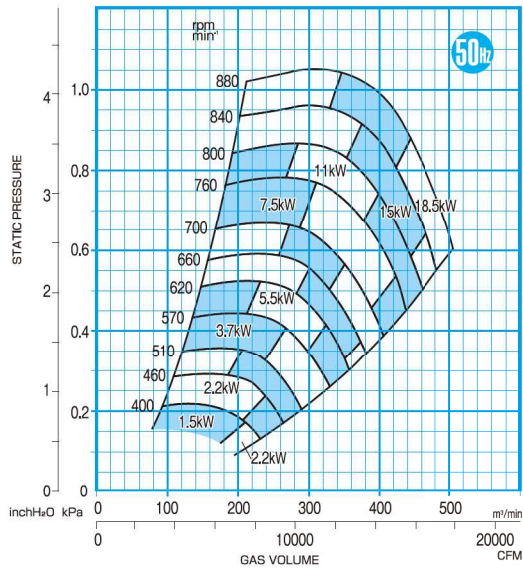

SOUND LEVEL

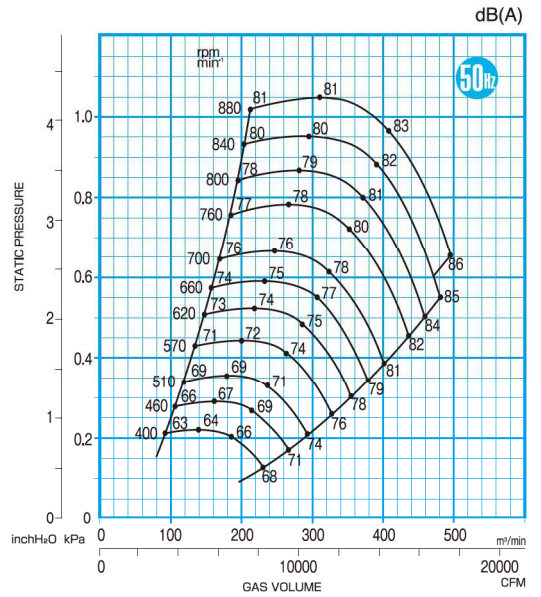

NSF302

CAPACITY RANGE CHART

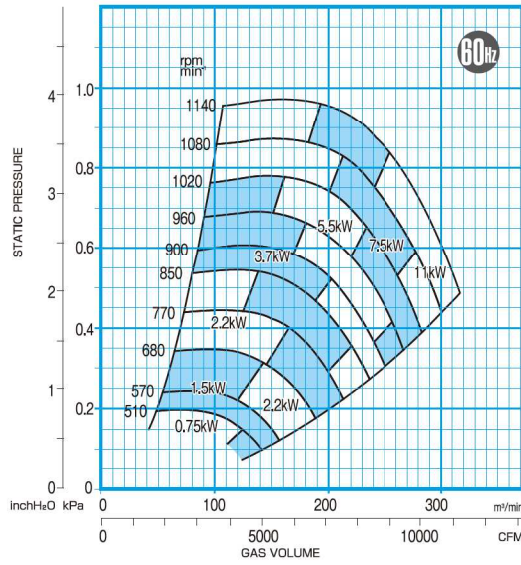

SOUND LEVEL

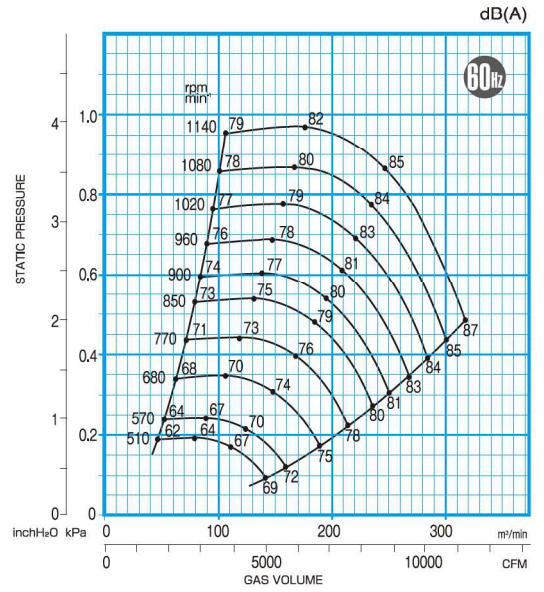

NSF402

CAPACITY RANGE CHART

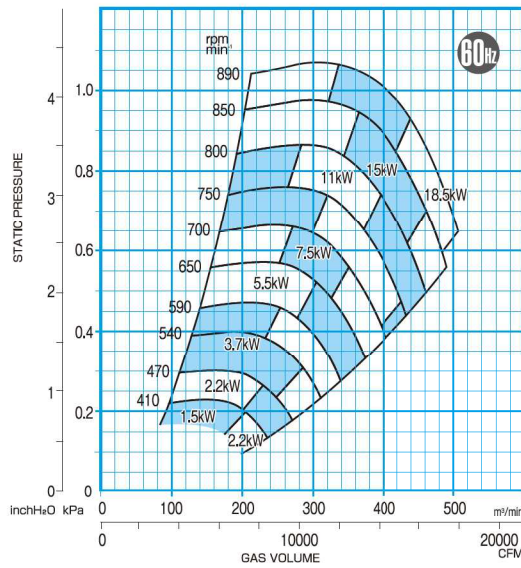

SOUND LEVEL

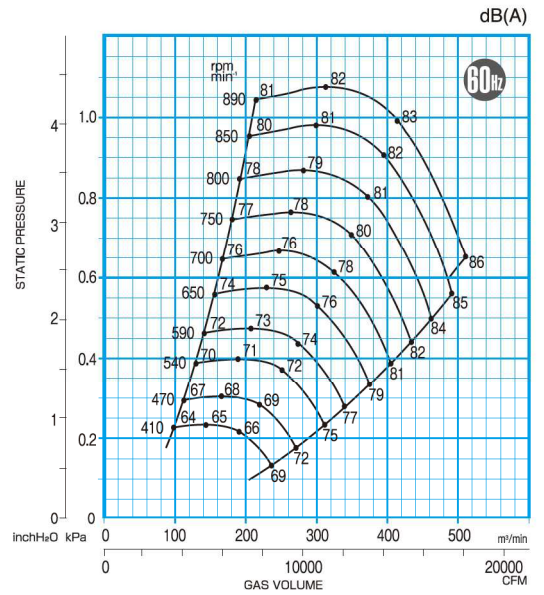

NSF302·402

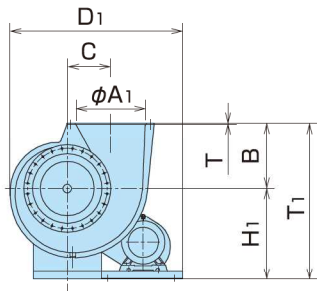
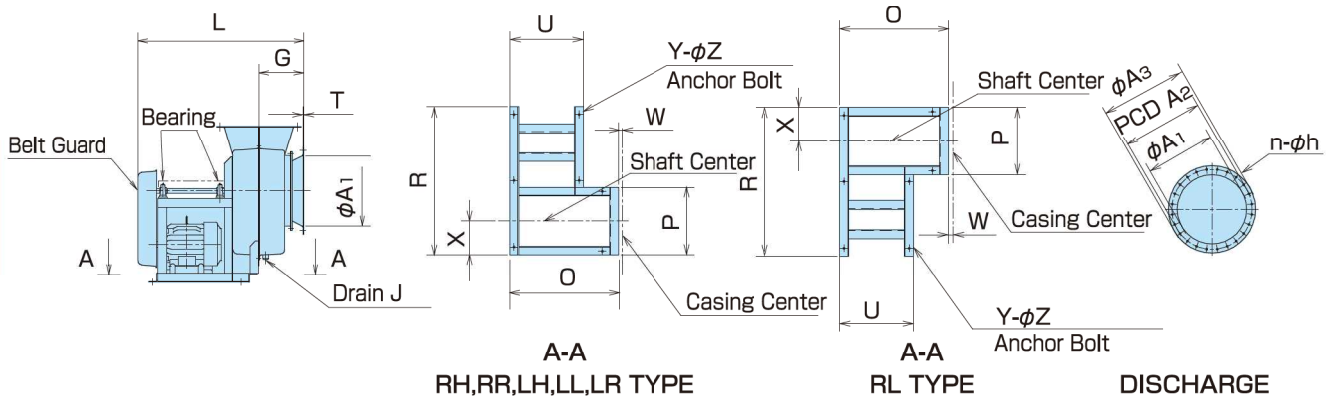

RH1

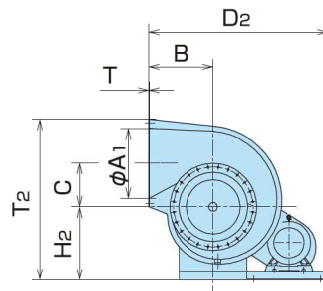

RR1

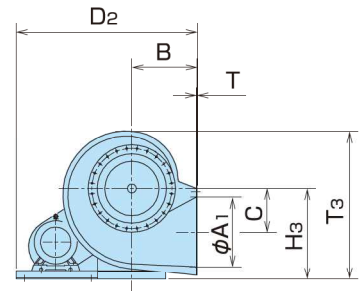

RL2

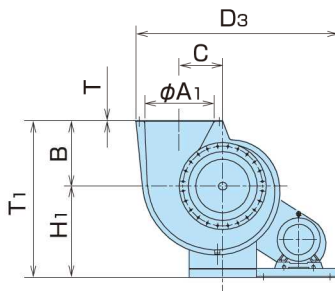

LH1

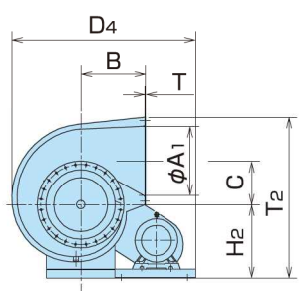

LL1

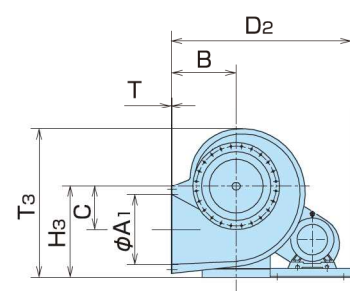

LR1

MODEL	CASING BODY													FLANGES						
	L	H ₁	H ₂	H ₃	B	C	D ₁	D ₂	D ₃	D ₄	T ₁	T ₂	T ₃	G	ϕA_1	PCD A_2	ϕA_3	n	h	T
NSF302	1220	670	540	670	480	320	1270	1330	1490	1357	1150	1180	1090	330	510	590	640	24	14	6
NSF402	1400	870	750	870	580	450	1443	1470	1690	1557	1450	1550	1423	400	600	660	700	28	14	6

MODEL	DRAIN	BASE							BODY WEIGHT(Kg)	BEARING	
	J	R	U	O	P	W	X	Y	Z	STANDARD	
NSF302	PF3/4"	1100	540	800	500	10	250	7	14	115	UCP207
NSF402	PF3/4"	1200	580	890	620	15	310	7	18	180	UCP309

※BODY WEIGHT : Not Including Motor Weight.

NSF302·402

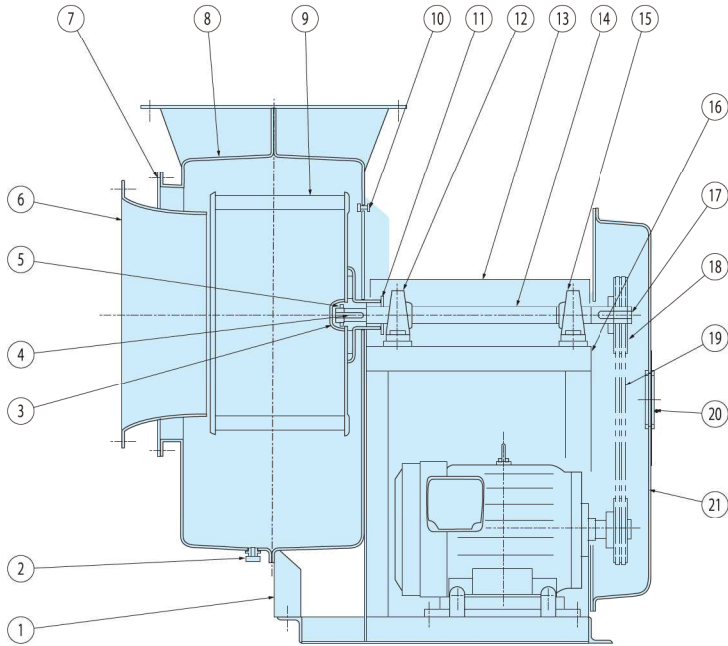

No.	NAME OF PART	MATERIALS	QTY
1	Casing Support	FRP	1
2	Drain Plug	FRP	1
3	Nut Cover	FRP	1
4	Impeller Key	S45C	1
5	Impeller Nut & Washer	SS400	1
6	Suction Cone	FRP	1
7	Suction Cone Set Bolt	SUS304	1set
8	Casing	FRP	1
9	Impeller	FRP	1
10	Casing Set Bolt	SUS304	1set
11	Gas Separator	HTPVC	1
12	Bearing	SUJ2	2
13	Shaft Guard	FRP	1
14	Shaft	S45C	1
15	Grease Nipple	Brass	2
16	Base	SS400	1
17	V-Pulley Key	S45C	1
18	V-Pulley	FC200	2
19	V-Belt	Rubber	1set
20	V-Belt Inspection Window	Acrylic Plate	1
21	Belt Guard	FRP	1

※Note: No drain plug on RL and LR types. Number of belts may vary from that shown in this drawing.

CTF151·201

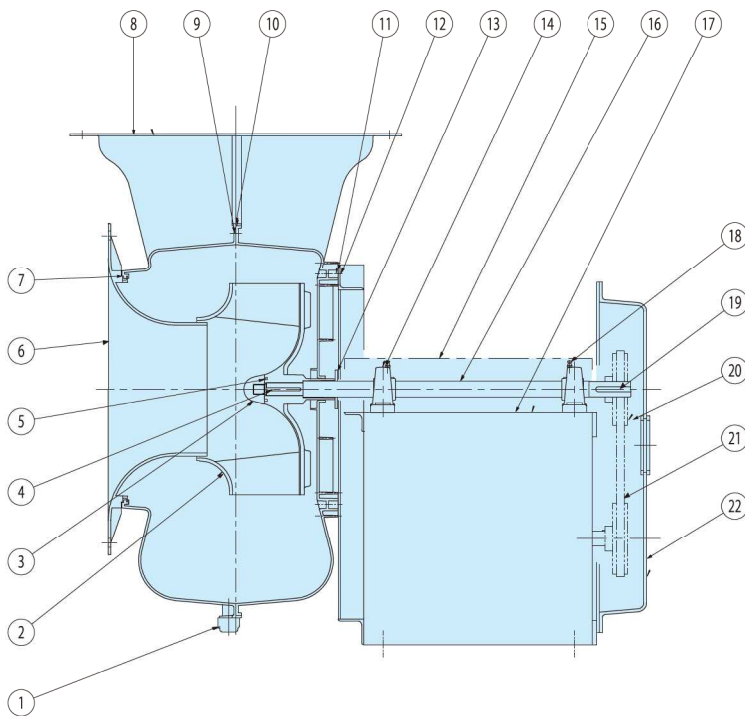

No.	NAME OF PART	MATERIALS	QTY
1	Drain Plug	PE	3
2	Impeller	FRP	1
3	Impeller Nut	PP	1
4	Impeller Key	S45C	1
5	O-Ring	Chloroprene	1
6	Suction Cone	PP(GF)	1
7	Packing	PE	1
8	Casing	PP(GF)	1
9	Casing Bolt	SUS304	1set
10	Casing Gasket	PE	1set
11	Insert Nut	Brass	1set
12	Casing Set Bolt	SUS304	1set
13	Gas Separator	PE	1
14	Bearing	SUJ2	2
15	Shaft Guard	FRP	1
16	Shaft	S45C	1
17	Base	SS400	1
18	Grease Nipple	Brass	2
19	V-Pulley Key	S45C	1
20	V-Pulley	FC200	1set
21	V-Belt	Rubber	1set
22	Belt Guard	FRP	1

Note: Number of belts may vary from that shown in this drawing.